

# ALLIANCE WINDOW COMPANY, INC

## Commercial Aluminum Windows & Doors

**PRODUCT INFORMATION:**  
**PROJECTED WINDOW**  
**2000 SERIES**  
**2" FRAME DEPTH**  
**MFG CODE: 2000 HC POIG**  
 - AAMA HC-80 RATED  
 - CRF OF 58  
 - STC 39  
 - 120 PSF STRUCTURAL  
 - 18 PSF WATER

\*NON-THERMAL FRAME SHOWN ALSO  
 AVAILABLE WITH THERMAL FRAMING

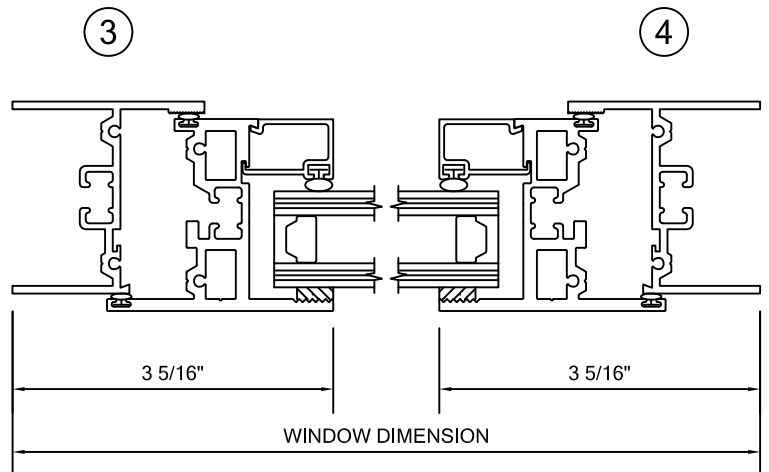
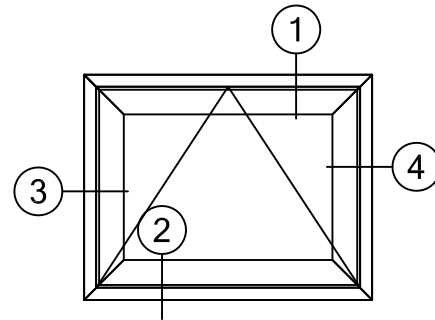
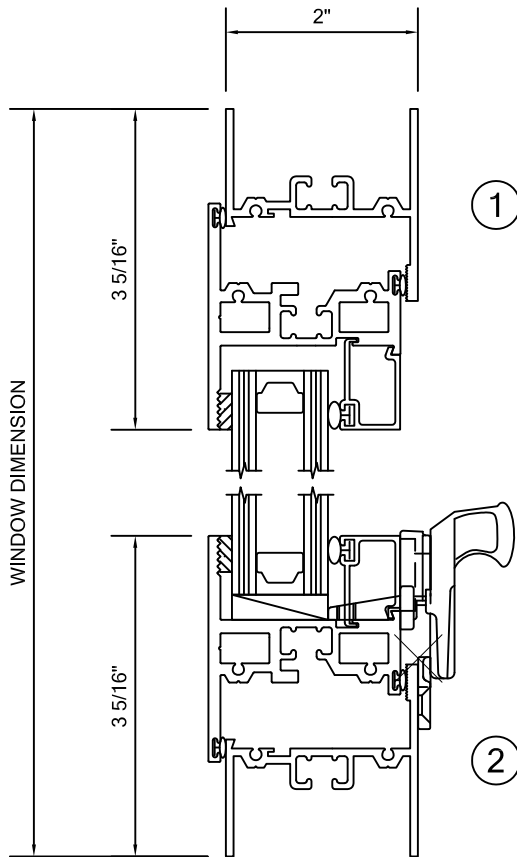

\*FRAMING SHOWN AS EQUAL LEG, ALSO AVAILABLE IN NAIL FIN,  
 FLANGE FRAME AND PROJECT SPECIFIC APPLICATIONS.